

Figure 1



Figure 2

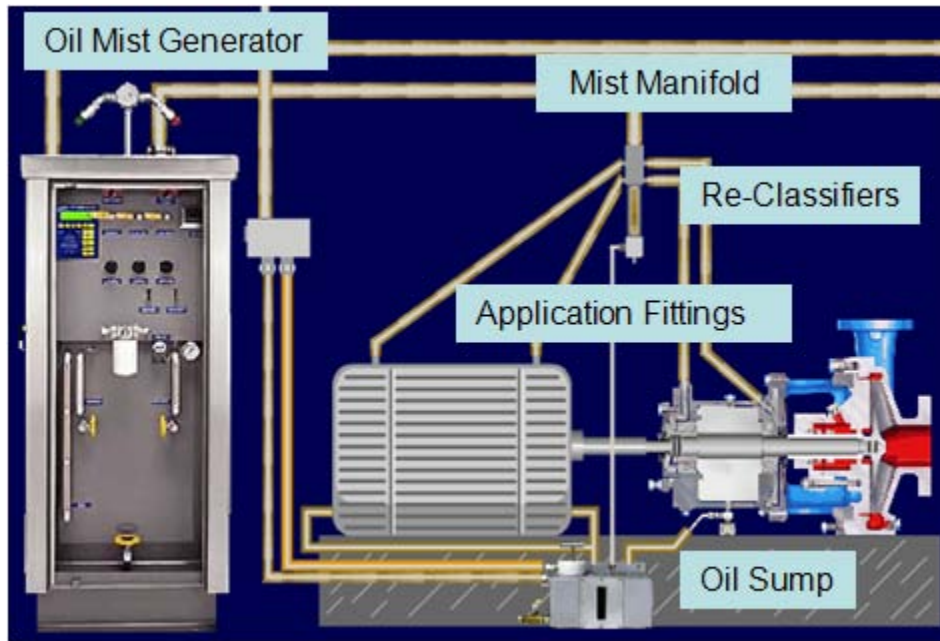

Figure 3



Figure 4

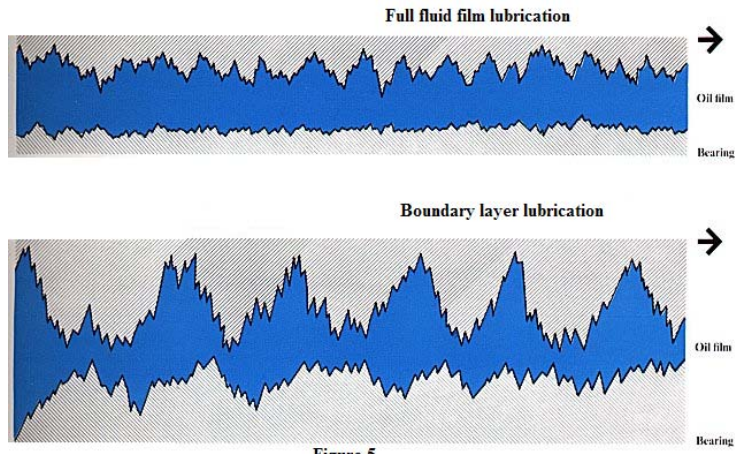

Figure 5

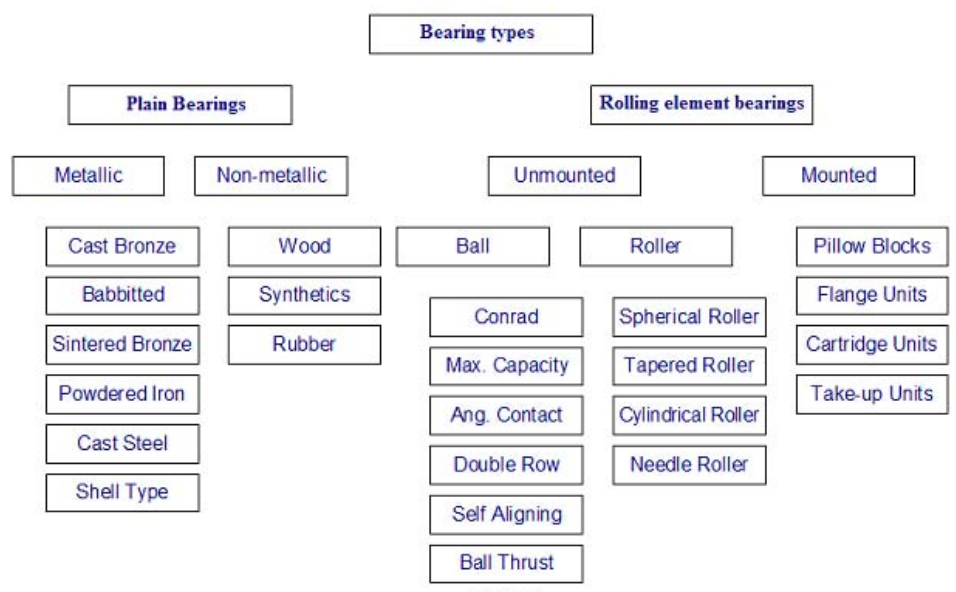

Figure 6



Figure 7

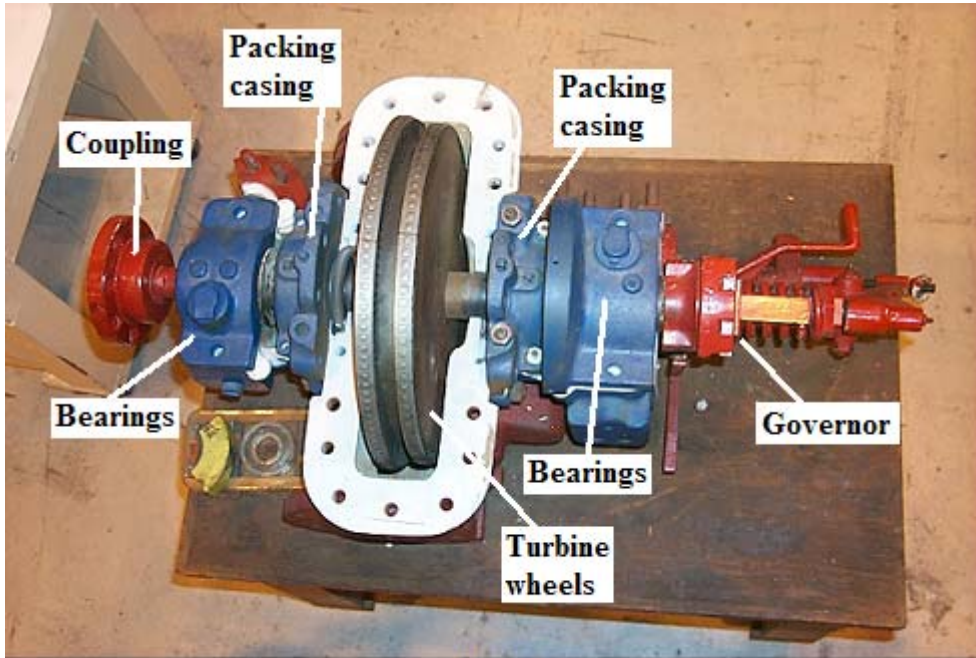

Figure 8

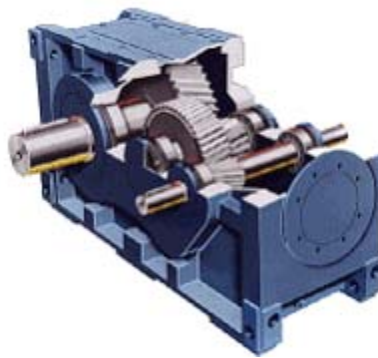

Figure 9

Straight-tube heat exchanger (one pass tube-side)

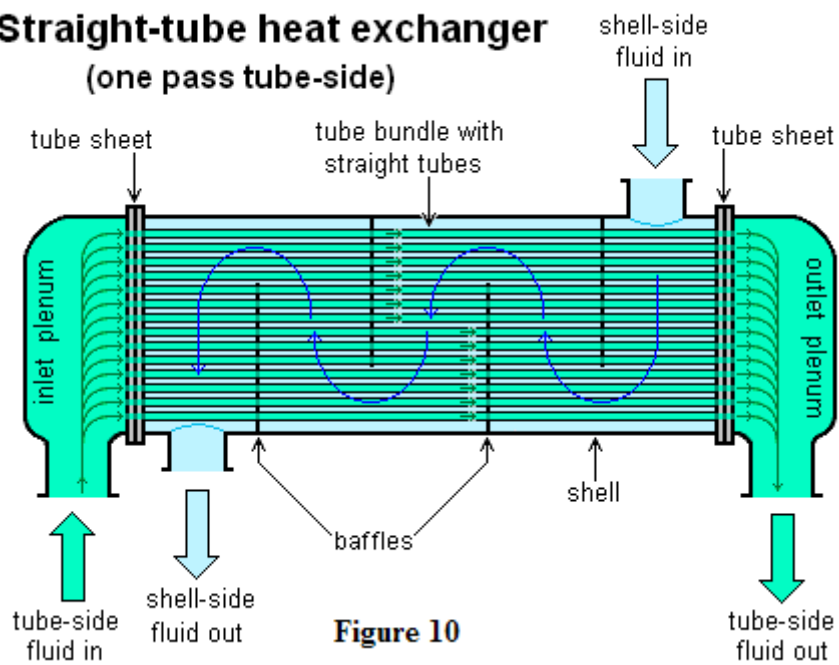

Figure 10

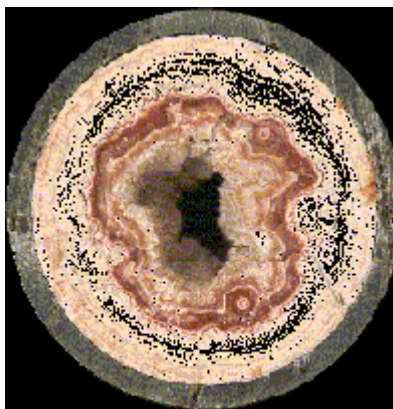
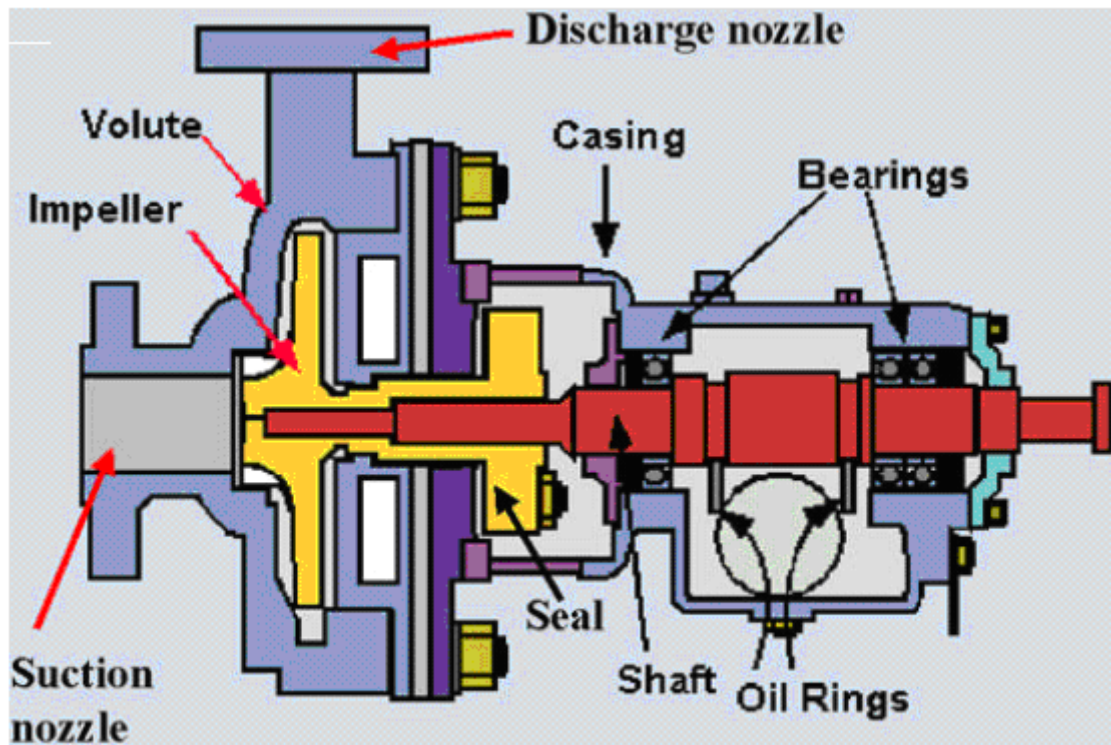

Figure 11



CENTRIFUGAL PUMP

Figure 12

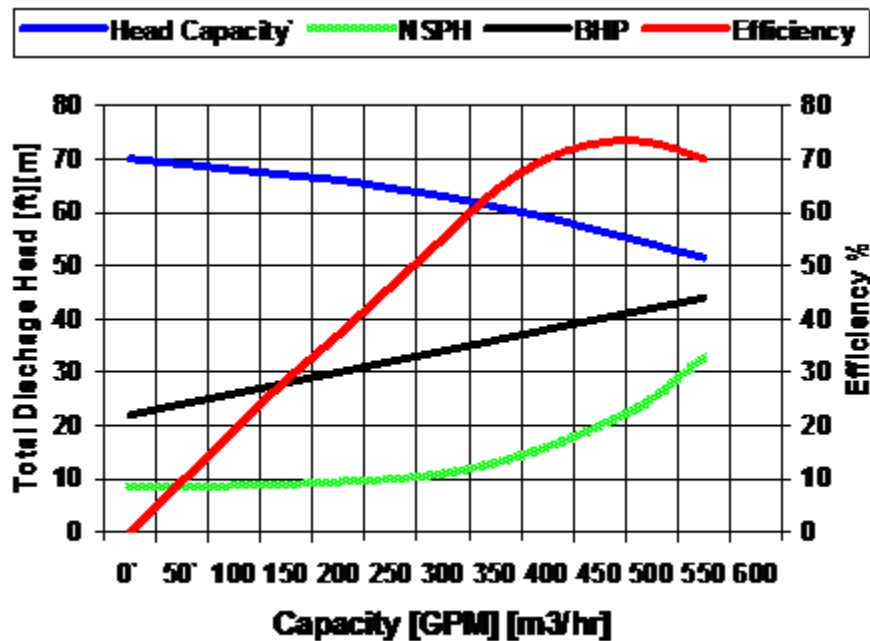

Figure 13

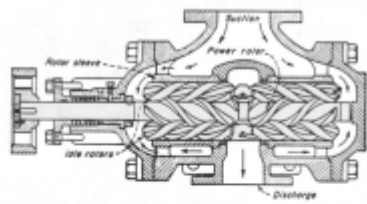

Figure 14

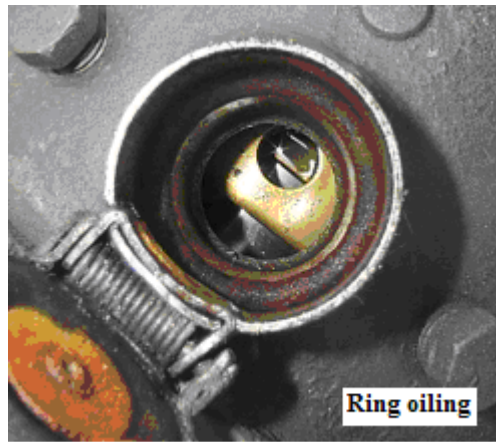
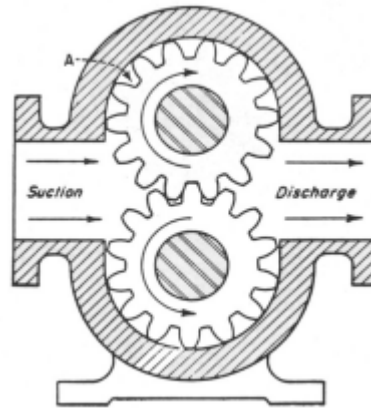

Figure 16



Cone of area averaged to get temperature.

Figure 17

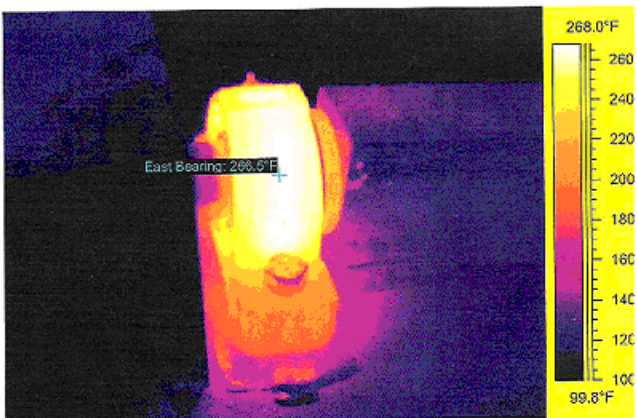

Figure 18



Figure 19

